

Rev	Date
A	11 / 08 / 2021

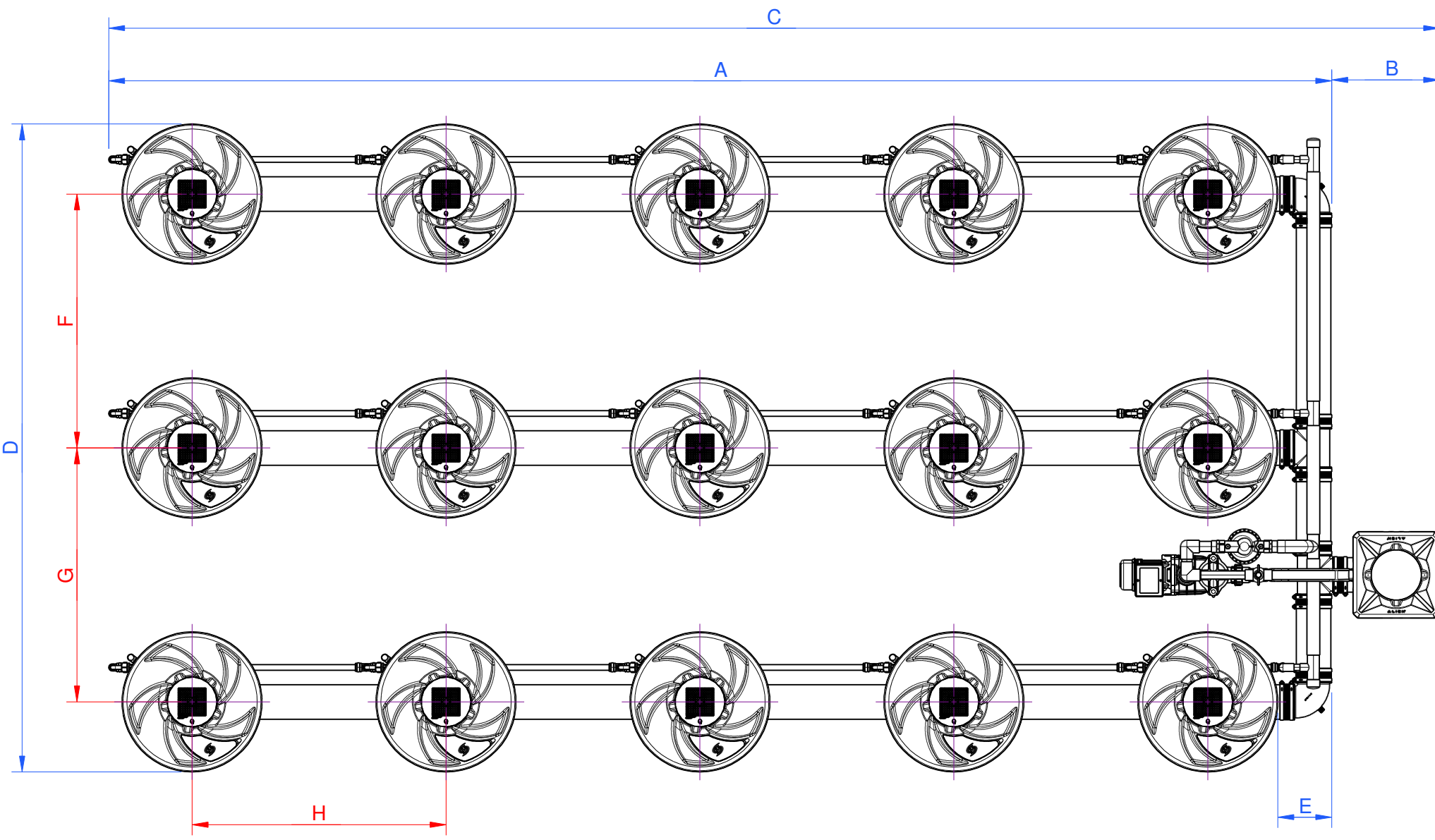

**Inverted Header:**

The header can be located inside the footprint as shown.

This option reduces overall length of system to dimension "A" (please refer to dimensions table).

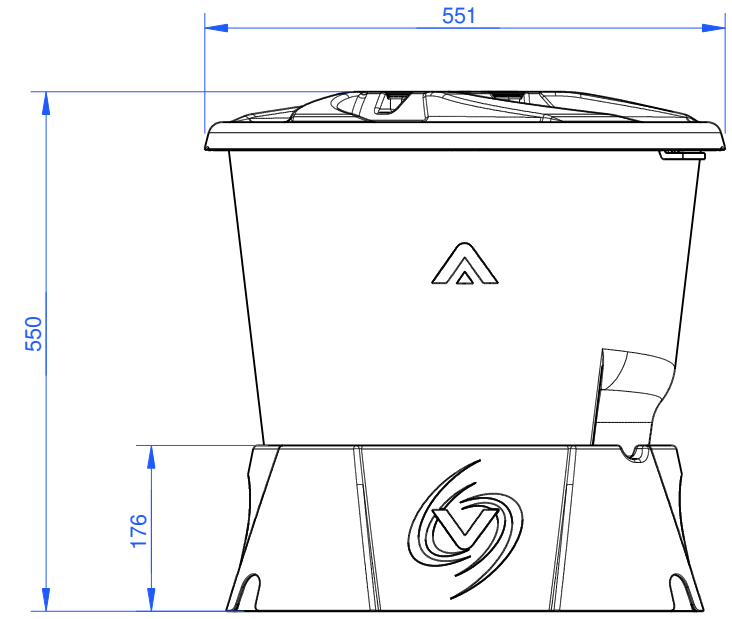
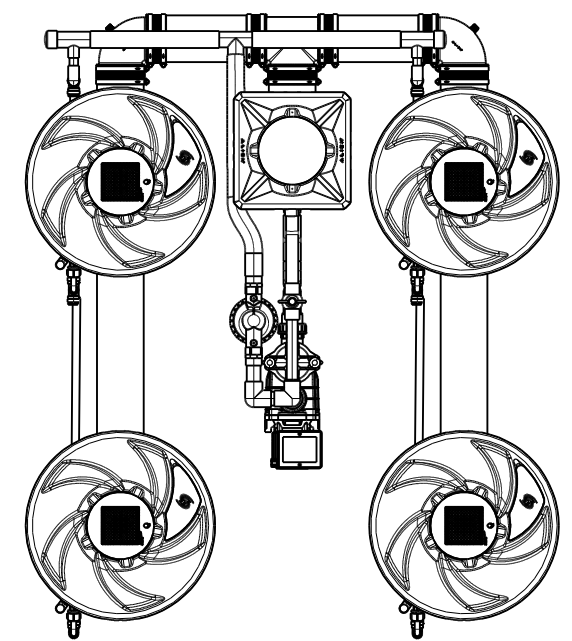

Dimensions (mm)	Minimum (mm)	Maximum (mm) @ 1m Plant Centres*
A	3110	4820
B	420	1070
C	3530	5890
D	1760	2550
E	210	210
F	560	1000
G	650	1000
H	580	1000

**\* Note:**  
Plant centres greater than 1m are possible with custom order lengths of 5" tubing, please contact [tech@alienhydroponics.co.uk](mailto:tech@alienhydroponics.co.uk) for more details.

	Project: V-SYSTEM	Scale 1 : 21
	Title: <b>3 Row 15 Pot</b>	
	Drawing Number: <b>V-3.15</b>	Sheet 1 of 1