

Rev	Date
A	12 / 08 / 2021

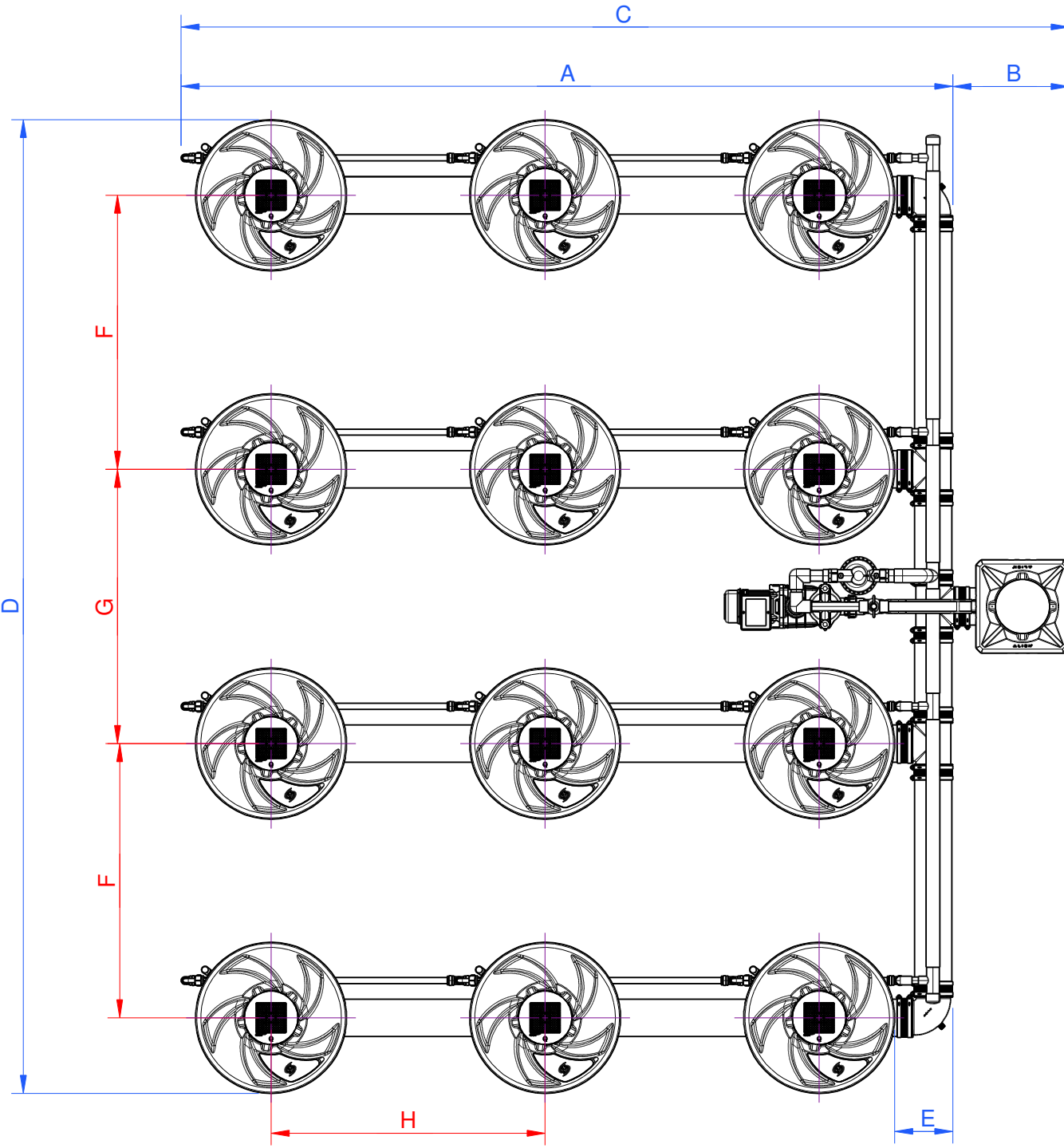

Inverted Header:

The header can be located inside the footprint as shown.

This option reduces overall length of system to dimension "A" (please refer to dimensions table).

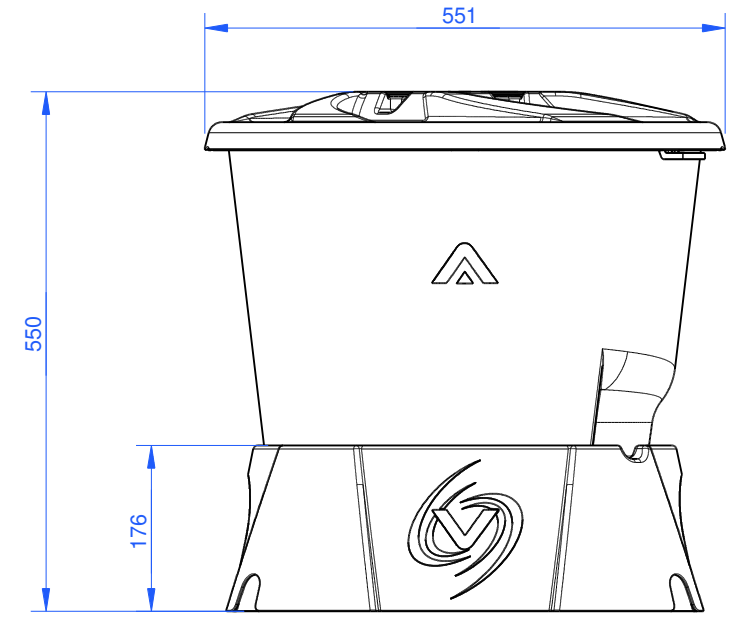
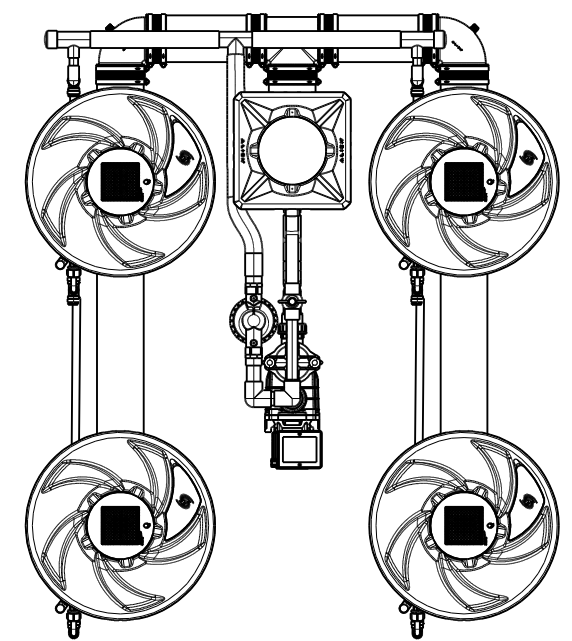

Dimensions (mm)	Minimum (mm)	Maximum (mm) @ 1m Plant Centres*
A	1950	2820
B	420	1070
C	2370	3890
D	2320	3550
E	210	210
F	560	1000
G	650	1000
H	580	1000

*** Note:**
Plant centres greater than 1m are possible with custom order lengths of 5" tubing, please contact tech@alienhydroponics.co.uk for more details.

	Project: V-SYSTEM	Scale 1 : 22
	Title: 4 Row 12 Pot	
	Drawing Number: V-4.12	Sheet 1 of 1